

JVC

SERVICE MANUAL

COLOR TELEVISION

BASIC CHASSIS

GC

AV-32230 /AG	AV-32260 /AG
AV-32230 /AH	AV-32260 /AH
AV-32230 /AM	AV-32260 /AM
AV-32230 /AR	AV-32260 /AR

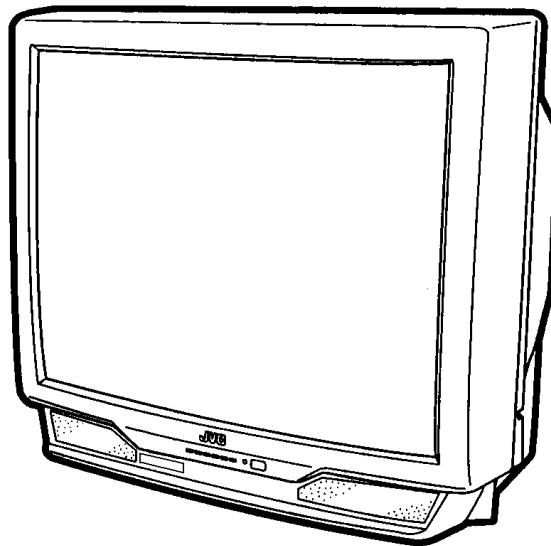
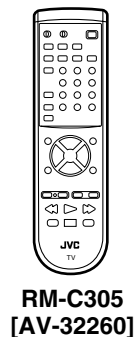
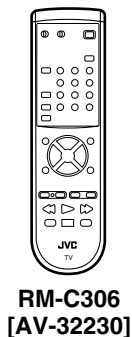

CONTENTS

- SPECIFICATIONS2
- SAFETY PRECAUTIONS3
- FEATURES4
- MAIN DIFFERENCE LIST5
- HOW TO IDENTIFY MODELS5
- FUNCTIONS6
- SPECIFIC SERVICE INSTRUCTIONS7
- SERVICE ADJUSTMENTS13
- ★ STANDARD CIRCUIT DIAGRAM (APPENDIX) 2-1
- PARTS LIST35

SPECIFICATIONS

Items	Contents
Dimensions (W × H × D)	30-1/4" × 26-1/4" × 21-1/2" / 76.8cm × 66.7cm × 54.8cm
Mass	112.2 lbs / 51.0 kg
TV RF System	CCIR(M)
Color Sound System	NTSC, BTSC System (Multi Channel Sound)
TV Receiving Channels and Frequency	
VL Band	(02~06) 54MHz~88MHz
VH Band	(07~13) 174MHz~216MHz
UHF Band	(14~69) 470MHz~806MHz
CATV Receiving Channels and Frequency	
Low Band	(02~06, A-8) by (02~06&01)
High Band	(07~13) by (07~13)
Mid Band	(A~1) by (14~22)
Super Band	(J~W) by (23~36)
Hyper Band	(W+1~W+28) by (37~64)
Ultra Band	(W+29~W+84) by (65~125)
Sub Mid Band	(A8, A4~A1) by (01, 96~99)
TV/CATV Total Channel	180 Channels
Intermediate Frequency	
Video IF Carrier	45.75MHz
Sound IF Carrier	41.25MHz (4.5MHz)
Color Sub Carrier	3.58MHz
Power Input	120V AC, 60Hz
Power Consumption	128W [AV-32230], 133W [AV-32260]
Picture Tube	32" (80cm) Measured Diagonally
High Voltage	31kV±1.3kV (at zero beam current)
Speaker	2" × 4-3/4" / 5 × 12cm Oval type × 2
Audio Power Output	3W × 2
Video / Audio Input (1 / 2 / 3)	Video(1,3) : 1Vp-p, 75Ω (RCA pin jack) Audio(1,2,3) : 500mVrms (-4dBs), High Impedance (RCA pin jack) S-Video (Input 1 Over) Y : 1Vp-p Positive (negative sync provided, when terminated with 75Ω) C : 0.286Vp-p (burst signal, when terminated with 75Ω) Component Input (Input 2) Y : 1Vp-p positive (negative sync provided, when terminated with 75Ω) P _B /P _R : 0.7Vp-p 75 Ω
Audio Output (Variable)	Variable : More then 0~1550mVrms (+6dBs) Low impedance (400Hz when modulated 100%) (RCA pin jack)
AV Compu link EX Input	3.5mm mini jack
Antenna terminal	75Ω(VHF/UHF) Terminal, F-Type Connector
Remote Control Unit	RM-C306-1A [AV-32230], RM-C305-1A [AV-32260] (AA/R6/UM-3 battery × 2)

Design & specifications are subject to change without notice.

SAFETY PRECAUTIONS

- The design of this product contains special hardware, many circuits and components specially for safety purposes. For continued protection, no changes should be made to the original design unless authorized in writing by the manufacturer. Replacement parts must be identical to those used in the original circuits. Service should be performed by qualified personnel only.
- Alterations of the design or circuitry of the products should not be made. Any design alterations or additions will void the manufacturer's warranty and will further relieve the manufacturer of responsibility for personal injury or property damage resulting therefrom.
- Many electrical and mechanical parts in the products have special safety-related characteristics. These characteristics are often not evident from visual inspection nor can the protection afforded by them necessarily be obtained by using replacement components rated for higher voltage, wattage, etc. Replacement parts which have these special safety characteristics are identified in the parts list of Service manual. **Electrical components having such features are identified by shading on the schematics and by (⚠) on the parts list in Service manual.** The use of a substitute replacement which does not have the same safety characteristics as the recommended replacement part shown in the parts list of Service manual may cause shock, fire, or other hazards.
- Use isolation transformer when hot chassis.**
The chassis and any sub-chassis contained in some products are connected to one side of the AC power line. An isolation transformer of adequate capacity should be inserted between the product and the AC power supply point while performing any service on some products when the HOT chassis is exposed.
- Don't short between the LIVE side ground and ISOLATED (NEUTRAL) side ground or EARTH side ground when repairing.**
Some model's power circuit is partly different in the GND. The difference of the GND is shown by the LIVE : (⊥) side GND, the ISOLATED(NEUTRAL) : (⚡) side GND and EARTH : (⊕) side GND. Don't short between the LIVE side GND and ISOLATED(NEUTRAL) side GND or EARTH side GND and never measure the LIVE side GND and ISOLATED(NEUTRAL) side GND or EARTH side GND at the same time with a measuring apparatus (oscilloscope etc.).
If above note will not be kept, a fuse or any parts will be broken.
- If any repair has been made to the chassis, it is recommended that the B1 setting should be checked or adjusted (See ADJUSTMENT OF B1 POWER SUPPLY).
- The high voltage applied to the picture tube must conform with that specified in Service manual. Excessive high voltage can cause an increase in X-Ray emission, arcing and possible component damage, therefore operation under excessive high voltage conditions should be kept to a minimum, or should be prevented. If severe arcing occurs, remove the AC power immediately and determine the cause by visual inspection (incorrect installation, cracked or melted high voltage harness, poor soldering, etc.). To maintain the proper minimum level of soft X-Ray emission, components in the high voltage circuitry including the picture tube must be the exact replacements or alternatives approved by the manufacturer of the complete product.
- Do not check high voltage by drawing an arc. Use a high voltage meter or a high voltage probe with a VTVM. Discharge the picture tube before attempting meter connection, by connecting a clip lead to the ground frame and connecting the other end of the lead through a 10kΩ 2W resistor to the anode button.
- When service is required, observe the original lead dress. Extra precaution should be given to assure correct lead dress in the high voltage circuit area. Where a short circuit has occurred, those components that indicate evidence of overheating should be replaced. Always use the manufacturer's replacement components.

10. Isolation Check

(Safety for Electrical Shock Hazard)

After re-assembling the product, always perform an isolation check on the exposed metal parts of the cabinet (antenna terminals, video/audio input and output terminals, Control knobs, metal cabinet, screwheads, earphone jack, control shafts, etc.) to be sure the product is safe to operate without danger of electrical shock.

(1) Dielectric Strength Test

The isolation between the AC primary circuit and all metal parts exposed to the user, particularly any exposed metal part having a return path to the chassis should withstand a voltage of 1100V AC (r.m.s.) for a period of one second.

(... Withstand a voltage of 1100V AC (r.m.s.) to an appliance rated up to 120V, and 3000V AC (r.m.s.) to an appliance rated 200V or more, for a period of one second.)

This method of test requires a test equipment not generally found in the service trade.

(2) Leakage Current Check

Plug the AC line cord directly into the AC outlet (do not use a line isolation transformer during this check.). Using a "Leakage Current Tester", measure the leakage current from each exposed metal part of the cabinet, particularly any exposed metal part having a return path to the chassis, to a known good earth ground (water pipe, etc.). Any leakage current must not exceed 0.5mA AC (r.m.s.).

However, in tropical area, this must not exceed 0.2mA AC (r.m.s.).

● Alternate Check Method

Plug the AC line cord directly into the AC outlet (do not use a line isolation transformer during this check.). Use an AC voltmeter having 1000 ohms per volt or more sensitivity in the following manner. Connect a 1500Ω 10W resistor paralleled by a 0.15μF AC-type capacitor between an exposed metal part and a known good earth ground (water pipe, etc.). Measure the AC voltage across the resistor with the AC voltmeter. Move the resistor connection to each exposed metal part, particularly any exposed metal part having a return path to the chassis, and measure the AC voltage across the resistor. Now, reverse the plug in the AC outlet and repeat each measurement. Any voltage measured must not exceed 0.75V AC (r.m.s.). This corresponds to 0.5mA AC (r.m.s.).

However, in tropical area, this must not exceed 0.3V AC (r.m.s.). This corresponds to 0.2mA AC (r.m.s.).

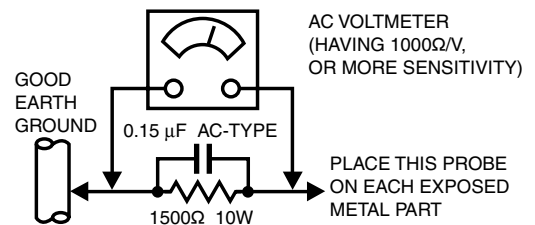

11. High voltage hold down circuit check.

After repair of the high voltage hold down circuit, this circuit shall be checked to operate correctly.

See item "How to check the high voltage hold down circuit".

This mark shows a fast operating fuse, the letters indicated below show the rating.



POWER CORD REPLACEMENT WARNING
Connecting the white line side of power cord to "WHT" character side.

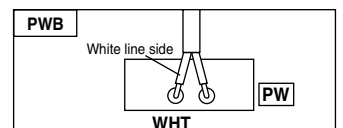

FEATURES

- Full-square CRT (cathode ray tube) reproduces fine textured picture in every detail.
- I²C bus control utilizes single chip ICs.
- Built in Twin Tuner system. [Only for AV-32260]
- Built-in HYPER-SURROUND system.
- Adoption of the Picture-In-Picture (PIP) function. [Only for AV-32260]
- 3 LINE DIGITAL COMB FILTER circuit improved picture quality.
- Component input terminal for taking best advantage of Component Video Signal.
- Audio Video input terminal. (S-input ×1, V-input ×2)
- Variable audio output terminal.
- Closed-caption broadcasts can be viewed.
- With AV COMPU LINK EX terminal.

■ SYSTEM BLOCK DIAGRAM

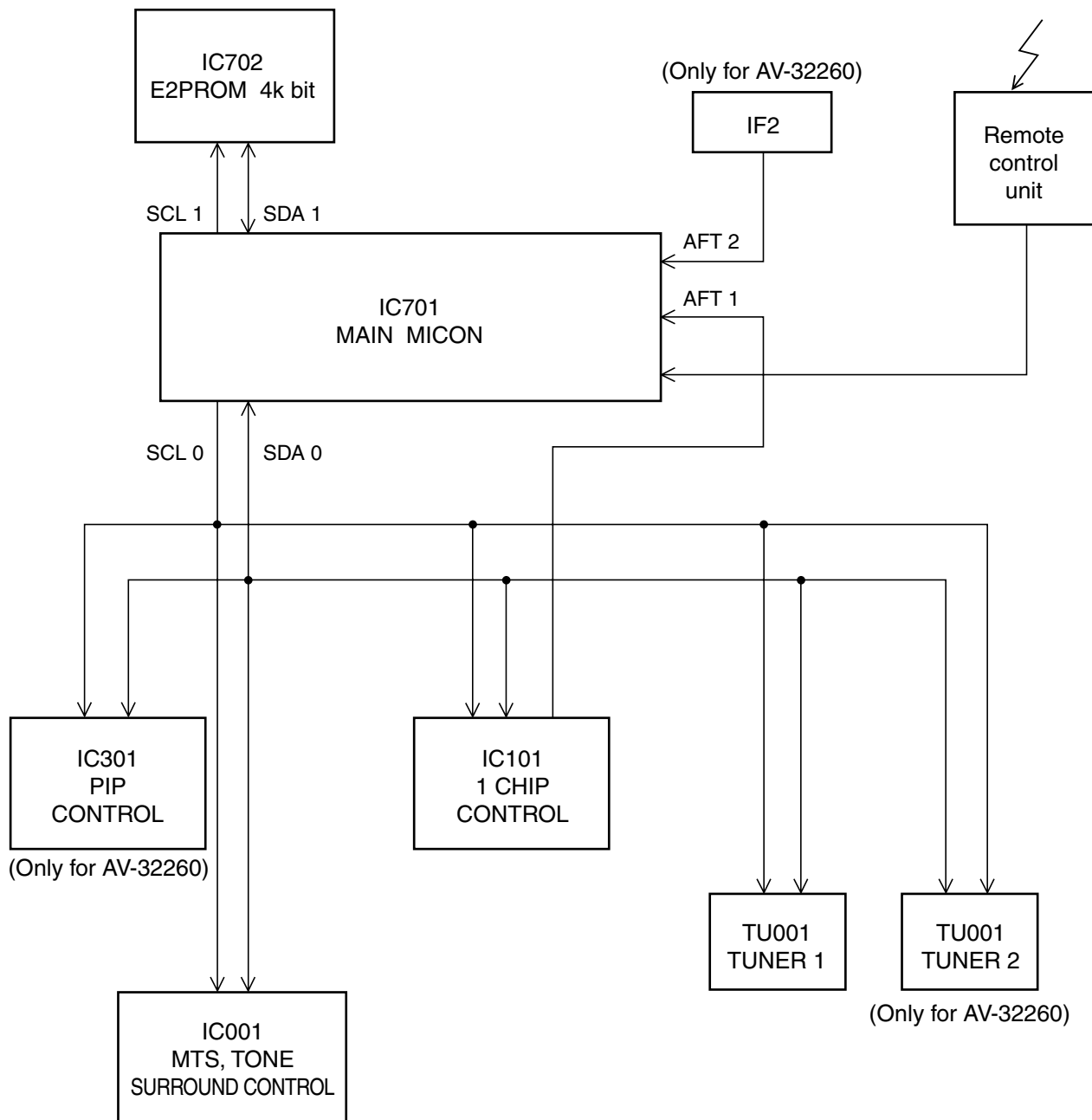

MAIN DIFFERENCE LIST

[AV-32230/AG & AV-32230/AH & AV-32230/AM & AV-32230/AR]

△	Model	AV-32230/AG	AV-32230/AH	AV-32230/AM	AV-32230/AR
	Part name				
	MAIN PWB	SGC-1029A-M2	SGC-1030A-M2	SGC-1032A-M2	SGC-1031A-M2
	CRT SOCKET PWB	SGC-3003A-M2	SGC-3004A-M2	SGC-3005A-M2	SGC-3011A-M2
△	PICTRE TUBE	A80QCF240X14L	A80LJF30X08-G	M80JUA061X06	A80EJ15K01
△	DEG. COIL	QQW0086-001	CELD066-002JA	←	←

[AV-32260/AG & AV-32260/AH & AV-32260/AM & AV-32260/AR]

△	Model	AV-32260/AG	AV-32260/AH	AV-32260/AM	AV-32260/AR
	Part name				
	MAIN PWB	SGC-1021A-M2	SGC-1022A-M2	SGC-1024A-M2	SGC-1023A-M2
	CRT SOCKET PWB	SGC-3003A-M2	SGC-3004A-M2	SGC-3005A-M2	SGC-3011A-M2
△	PICTURE TUBE	A80QCF240X14L	A80LJF30X08-G	M80JUA061X06	A80AEJ15X01
△	DEG. COIL	QQW0086-001	CELD066-002JA	←	←

HOW TO IDENTIFY MODELS

- The difference between AV-32230/AG, AV-32230/AH, AV-32230/AM and AV-32230/AR is in the PICTURE TUBE. As the result of the difference in PICTURE TUBE, the MAIN PWB also differ.

△	Model	AV-32230/AG	AV-32230/AH	AV-32230/AM	AV-32230/AR
△	Parts name				
△	RATING LABEL	LC31139-001A-A	←	←	←
		<p>INDICATED AV-32230</p> <p>INDICATED "AG"</p>	<p>INDICATED AV-32230</p> <p>INDICATED "AH"</p>	<p>INDICATED AV-32230</p> <p>INDICATED "AM"</p>	<p>INDICATED AV-32230</p> <p>INDICATED "AR"</p>

- The difference between AV-32260/AG, AV-32260/AH, AV-32260/AM and AV-32260/AR is in the PICTURE TUBE. As the result of the difference in PICTURE TUBE, the MAIN PWB also differ.

△	Model	AV-32260/AG	AV-32260/AH	AV-32260/AM	AV-32260/AR
△	Parts name				
△	RATING LABEL	LC31139-001A-A	←	←	←
		<p>INDICATED AV-32260</p> <p>INDICATED "AG"</p>	<p>INDICATED AV-32260</p> <p>INDICATED "AH"</p>	<p>INDICATED AV-32260</p> <p>INDICATED "AM"</p>	<p>INDICATED AV-32260</p> <p>INDICATED "AR"</p>

FUNCTIONS

■ FRONT PANEL

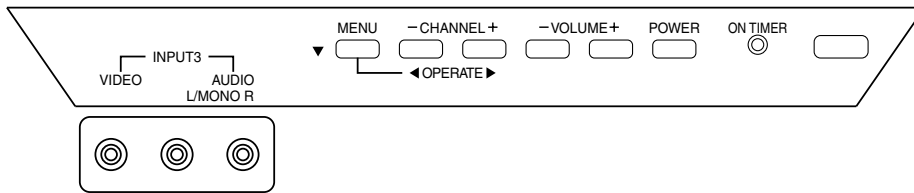

■ REAR PANEL

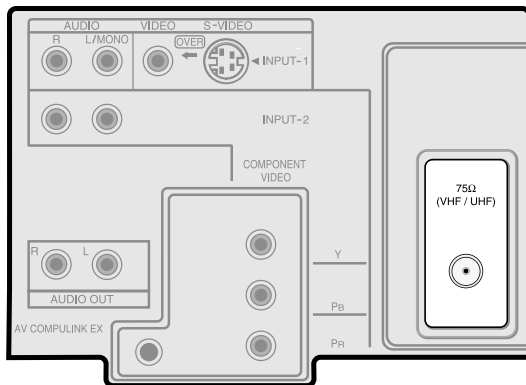

■ REMOTE CONTROL UNIT (RM-C305-1A) [AV-32260]

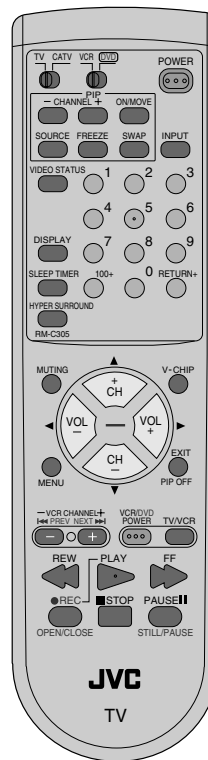

(RM-C306-1A) [AV-32230]

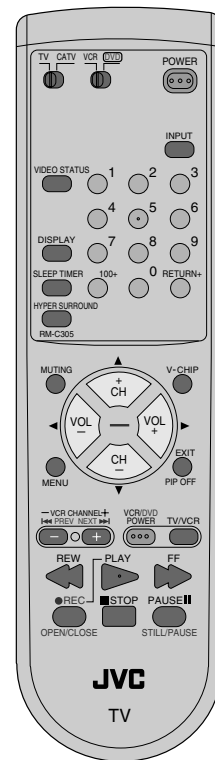

SPECIFIC SERVICE INSTRUCTIONS

DISASSEMBLY PROCEDURE

REMOVING THE REAR COVER

1. Unplug the power supply cord.
2. Remove the 11 screws marked (A) as shown in Fig.1.
3. Withdraw the REAR COVER toward you.

[CAUTION]

- When reinstalling the rear cover, carefully push it inward after inserting the MAIN PWB into the rear cover groove.

REMOVING THE CHASSIS

- After removing the rear cover.
1. Slightly raise the both sides of the chassis by hand and remove the 3 claws marked (B) under the chassis from the front cabinet as shown in Fig.1.
 2. Withdraw the chassis backward along the rail in the arrow direction marked (C) as shown in Fig.1.

(If necessary, take off the wire clamp, connector's etc.)

* When conducting a check with power supplied, be sure to confirm that the CRT earth wire is connected to the CRT SOCKET PWB and the MAIN PWB.

REMOVING THE TERMINAL BOARD

- After removing the rear cover.
1. Remove the 4 screws marked (D) as shown in Fig.1.
 2. When you pull out the TERMINAL BOARD in the direction of arrow marked (E) as shown in Fig.1, it can be removed.

REMOVING THE FRONT CONTROL AND FRONT AV INPUT PW BOARDS

- After removing the rear cover and chassis.
1. Remove the 2 screws marked (F) and the 2 screws marked (G) as shown in Fig.1.
 2. Then remove the FRONT CONTROL PWB and FRONT AV INPUT PWB.

(If necessary, take off the wire, connector's etc.)

REMOVING THE SPEAKER

- After removing the rear cover.
1. Remove the 2 screws marked (H) as shown in Fig.1.
 2. Withdraw the speaker backward.
 3. Follow the same steps when removing the other hand speaker.

CHECKING THE MAIN PW BOARD

1. To check the back side of the MAIN PW Board.
 - 1) Pull out the chassis. (Refer to REMOVING THE CHASSIS).
 - 2) Erect the chassis vertically so that you can easily check the back side of the MAIN PW Board.

[CAUTION]

- When erecting the chassis, be careful so that there will be no contacting with other PW Board.
- Before turning on power, make sure that the CRT earth wire and other connectors are properly connected.

WIRE CLAMPING AND CABLE TYING

1. Be sure clamp the wire.
2. Never remove the cable tie used for tying the wires together. Should it be inadvertently removed, be sure to tie the wires with a new cable tie.

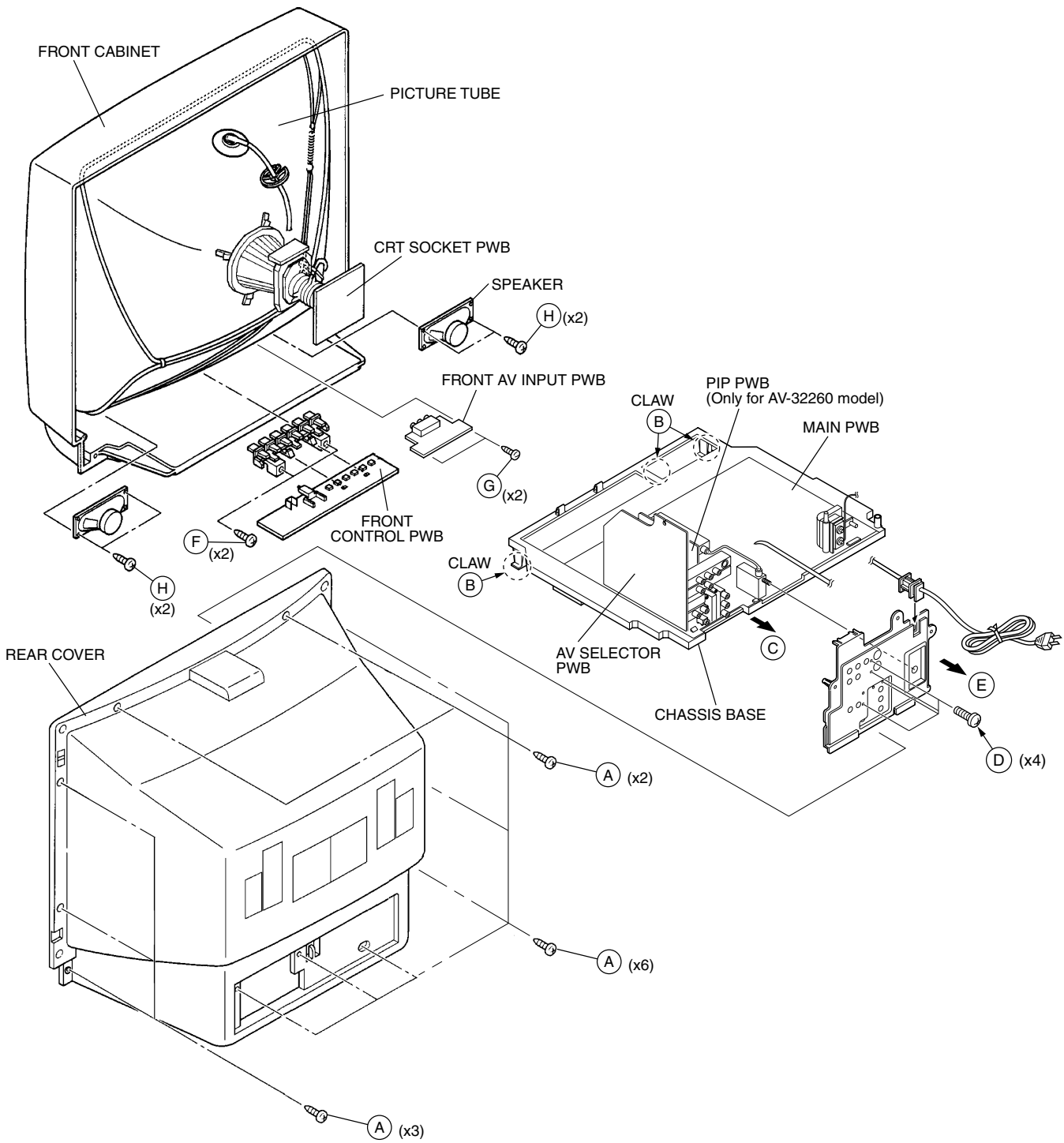

Fig.1

REMOVING THE CRT

* Replacement of the CRT should be performed by 2 or more persons.

- After removing the rear cover, chassis etc.,
- 1. Putting the CRT change table on soft cloth, the CRT change table should also be covered with such soft cloth (shown in Fig. 2).
- 2. While keeping the surface of CRT down, mount the TV set on the CRT change table balanced will as shown in Fig. 3.
- 3. Remove 4 screws marked by arrows with a box type screwdriver as shown in Fig. 3.
- Since the cabinet will drop when screws have been removed, be sure to support the cabinet with hands.
- 4. After 4 screws have been removed, put the cabinet slowly on cloth (At this time, be carefully so as not to damage the front surface of the cabinet) shown in Fig. 4.
- The CRT should be assembled according to the opposite sequence of its dismounting steps.

* The CRT change table should preferably be smaller than the CRT surface, and its height be about 35cm.

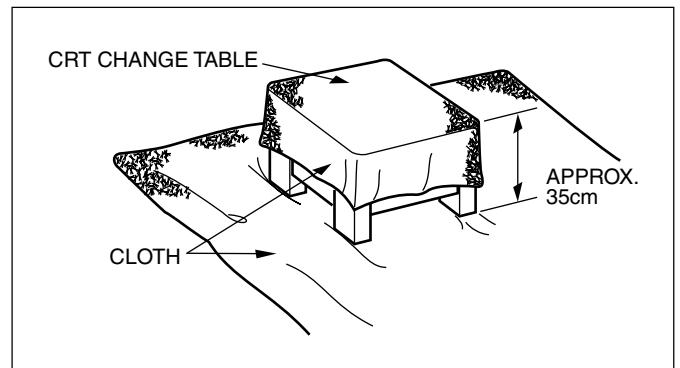

Fig. 2

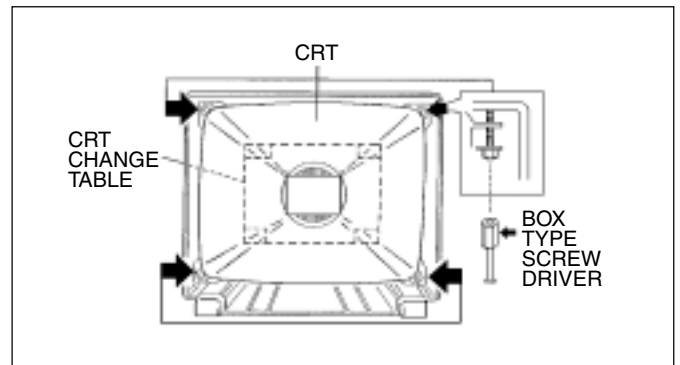

Fig. 3

COATING OF SILICON GREASE FOR ELECTRICAL INSULATION ON THE CRT ANODE CAP SECTION

- Subsequent to replacement of the CRT and HV transformer or repair of the anode cap, etc. by dismounting them, be sure to coat silicon grease for electrical insulation as shown in Fig. 5.
- Wipe around the anode button with clean and dry cloth. (Fig. 5)
- Coat silicon grease on the section around the anode button. At this time, take care so that any silicon greases does not sticks to the anode button. (Fig. 6)

★ Silicon grease product No. KS - 650N

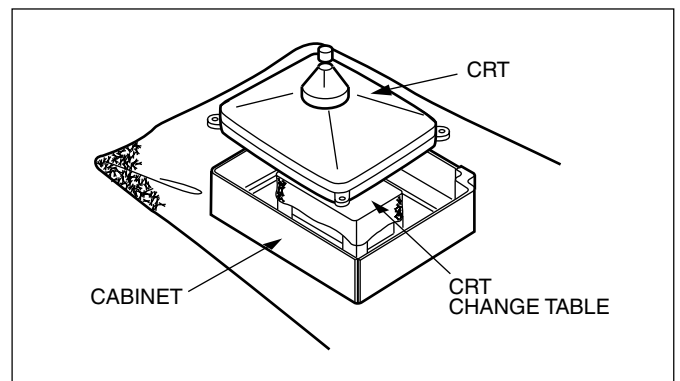

Fig. 4

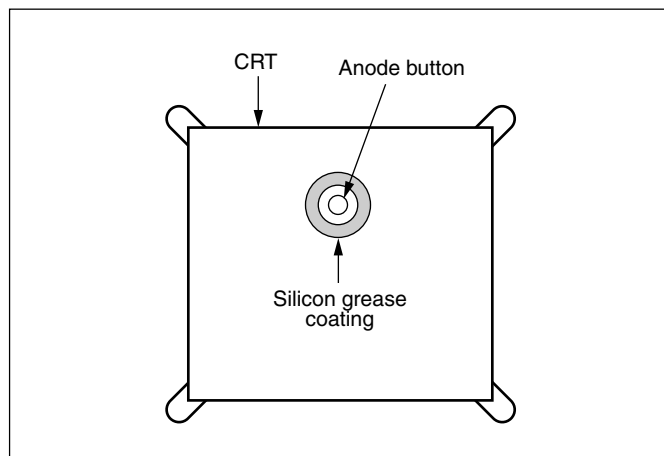

Fig. 5

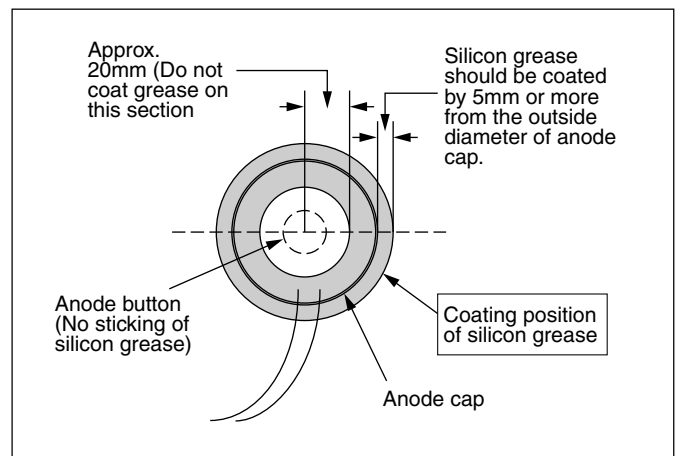

Fig. 6

MEMORY IC REPLACEMENT

1. Memory IC

This model use a memory IC.

This memory IC stores data for proper operation of the video and deflection circuits.

When replacing, be sure to use an IC containing this (initial value) data.

2. Memory IC replacement procedure

Procedure	Screen display																														
<p>(1) Power off Switch off the power and disconnect the power cord from the outlet.</p>																															
<p>(2) Replace the memory IC Initial value must be entered into the new IC.</p>																															
<p>(3) Power on Connect the power cord to the outlet and switch on the power.</p>																															
<p>(4) System constant check and setting</p> <ol style="list-style-type: none"> 1) Press SLEEP TIMER key and, while the indication of "SLEEP TIMER 0 MIN." is being displayed, press DISPLAY key and VIDEO STATUS key on the remote control unit simultaneously. 2) The SERVICE MENU screen of Fig.1 is displayed. 3) While the SERVICE MENU is displayed, again simultaneously press the DISPLAY and VIDEO STATUS keys to display the Fig.2 SYSTEM CONSTANT screen. 4) Refer to the SYSTEM CONSTANT table and check the setting items. Where these differ, select the setting item with the MENU UP/DOWN key and adjust the setting with the MENU LEFT/RIGHT keys. (The letters of the selected item are displayed in yellow.) 5) After adjusting, release the MENU LEFT/RIGHT key to store the setting value. 6) Press the EXIT key twice to return the normal screen. 	<div style="border: 1px solid black; padding: 5px; margin-bottom: 10px;"> <p style="text-align: center; border-bottom: 1px solid black;">SERVICE MENU</p> <table style="width: 100%; border-collapse: collapse;"> <tr> <td style="width: 50%;">PICTURE</td> <td style="width: 50%;">SOUND</td> </tr> <tr> <td>THEATER</td> <td>OTHERS</td> </tr> <tr> <td>LOW LIGHT</td> <td>HIGH LIGHT</td> </tr> <tr> <td>RF AFC</td> <td>I2C BUS CTRL</td> </tr> </table> <p style="font-size: small;">SELECT BY ▲ ▼ OPERATE BY ◀ ▶ EXIT BY (EXIT)</p> </div> <p style="text-align: center;">[AV-32230]</p> <div style="border: 1px solid black; padding: 5px; margin-bottom: 10px;"> <p style="text-align: center; border-bottom: 1px solid black;">SERVICE MENU</p> <table style="width: 100%; border-collapse: collapse;"> <tr> <td style="width: 50%;">PICTURE</td> <td style="width: 50%;">SOUND</td> </tr> <tr> <td>THEATER</td> <td>OTHERS</td> </tr> <tr> <td>PIP</td> <td></td> </tr> <tr> <td>LOW LIGHT</td> <td>HIGH LIGHT</td> </tr> <tr> <td>RF AFC1</td> <td>RF AFC2</td> </tr> <tr> <td>TU2 VCO</td> <td>I2C BUS CTRL</td> </tr> </table> <p style="font-size: small;">SELECT BY ▲ ▼ OPERATE BY ◀ ▶ EXIT BY (EXIT)</p> </div> <p style="text-align: center;">[AV-32260]</p> <p style="text-align: center;">Fig.1</p> <div style="border: 1px solid black; padding: 5px;"> <p style="text-align: center; border-bottom: 1px solid black;">SYSTEM CONSTANT</p> <table style="width: 100%; border-collapse: collapse;"> <tr> <td style="width: 60%;">MODEL</td> <td style="width: 40%;">: ***-*****</td> </tr> <tr> <td>CCD</td> <td>: YES</td> </tr> <tr> <td>V-CHIP</td> <td>: YES</td> </tr> <tr> <td>CAN V-CHIP</td> <td>: YES</td> </tr> <tr> <td colspan="2">***** **</td> </tr> </table> <p style="font-size: small;">SELECT BY ▲ ▼ OPERATE BY ◀ ▶ EXIT BY (EXIT)</p> </div> <p style="text-align: center;">Fig.2</p>	PICTURE	SOUND	THEATER	OTHERS	LOW LIGHT	HIGH LIGHT	RF AFC	I2C BUS CTRL	PICTURE	SOUND	THEATER	OTHERS	PIP		LOW LIGHT	HIGH LIGHT	RF AFC1	RF AFC2	TU2 VCO	I2C BUS CTRL	MODEL	: ***-*****	CCD	: YES	V-CHIP	: YES	CAN V-CHIP	: YES	***** **	
PICTURE	SOUND																														
THEATER	OTHERS																														
LOW LIGHT	HIGH LIGHT																														
RF AFC	I2C BUS CTRL																														
PICTURE	SOUND																														
THEATER	OTHERS																														
PIP																															
LOW LIGHT	HIGH LIGHT																														
RF AFC1	RF AFC2																														
TU2 VCO	I2C BUS CTRL																														
MODEL	: ***-*****																														
CCD	: YES																														
V-CHIP	: YES																														
CAN V-CHIP	: YES																														
***** **																															
<p>(5) Receive channel setting Refer to the OPERATING INSTRUCTIONS(USER'S GUIDE) and set the receive channels (Channels Preset) as described.</p>																															
<p>(6) User settings Check the user setting items according to Table 2. Where these do not agree, refer to the OPERATING INSTRUCTIONS (USER'S GUIDE) and set the items as described.</p>																															
<p>(7) SERVICE MENU setting Verify what to set in the SERVICE MENU, and set whatever is necessary.(Fig.1) Refer to the SERVICE ADJUSTMENT for setting.</p>																															

TABLE 1 (System Constant setting)

Setting item	Setting content	Setting value	
		AV-32230	AV-32260
MODEL		AV-32230A	AV-32260A
CCD	<input type="checkbox"/> YES <input type="checkbox"/> NO	YES	
V-CHIP	<input type="checkbox"/> YES <input type="checkbox"/> NO	YES	
CAN V-CHIP	<input type="checkbox"/> YES <input type="checkbox"/> NO	YES	

TABLE 2 (User setting value)

Setting item	Setting value
1. Use remote controller keys	
POWER	OFF
CHANNEL	CH-02
VOLUME	5
INPUT	TV
HYPER SURROUND	OFF
DISPLAY	OFF
BBE	ON
SLEEP TIMER	0
VIDEO STATUS	CHOICE
PIP SOURCE	CH-04
PIP ON (PIP POSITION)	LEFT LOWER SIDE } Only for AV-32260
2. Setting of MENU	
PICTURE ADJUST	
TINT	CENTER
COLOR	CENTER
PICTURE	CENTER
BRIGHT	CENTER
DETAIL	CENTER
NOISE MUTING	ON
SET VIDEO STATUS	ALL CENTER
SOUND ADJUST	
BASS	CENTER
TREBLE	CENTER
BALANCE	CENTER
MTS	STEREO
CLOCK/TIMERS	
SET CLOCK	Unnecessary to set
ON/OFF TIMER	NO
INITIAL SETUP	
TV SPEAKER	ON
LANGUAGE	ENG
CLOSED CAPTION	OFF
AUTO TUNER SETUP	TUNER MODE : AIR
CHANNEL SUMMARY	Unnecessary to set
V-CHIP	OFF
SET LOCK CODE	Unnecessary to set

REPLACEMENT OF CHIP COMPONENT

■ CAUTIONS

1. Avoid heating for more than 3 seconds.
2. Do not rub the electrodes and the resist parts of the pattern.
3. When removing a chip part, melt the solder adequately.
4. Do not reuse a chip part after removing it.

■ SOLDERING IRON

1. Use a high insulation soldering iron with a thin pointed end of it.
2. A 30w soldering iron is recommended for easily removing parts.

■ REPLACEMENT STEPS

1. How to remove Chip parts

◆ Resistors, capacitors, etc.

- (1) As shown in the figure, push the part with tweezers and alternately melt the solder at each end.

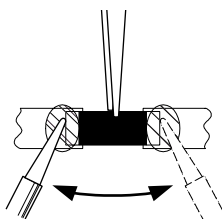

- (2) Shift with tweezers and remove the chip part.

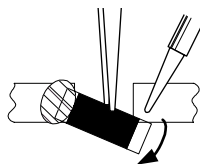

◆ Transistors, diodes, variable resistors, etc.

- (1) Apply extra solder to each lead.

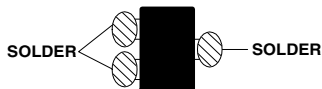

- (2) As shown in the figure, push the part with tweezers and alternately melt the solder at each lead. Shift and remove the chip part.

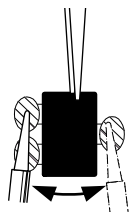

Note : After removing the part, remove remaining solder from the pattern.

2. How to install Chip parts

◆ Resistors, capacitors, etc.

- (1) Apply solder to the pattern as indicated in the figure.

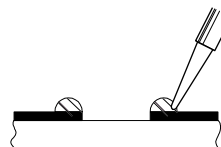

- (2) Grasp the chip part with tweezers and place it on the solder. Then heat and melt the solder at both ends of the chip part.

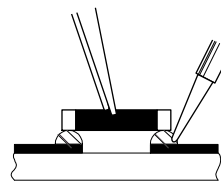

◆ Transistors, diodes, variable resistors, etc.

- (1) Apply solder to the pattern as indicated in the figure.
- (2) Grasp the chip part with tweezers and place it on the solder.
- (3) First solder lead **A** as indicated in the figure.

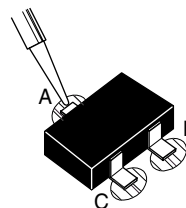

- (4) Then solder leads **B** and **C**.

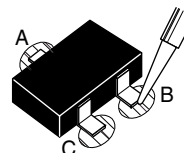

SERVICE ADJUSTMENTS

ADJUSTMENT PREPARATION

1. You can make the necessary adjustments for this unit with either the remote control unit or with the adjustment equipment and parts as given below.
2. Adjustment with the remote control unit is made on the basis of the initial setting values, however, the new setting values which set the screen to its optimum condition may differ from the initial settings.
3. Make sure that AC power is turned on correctly.
4. Turn on the power for the set and test equipment before use, and start the adjustment procedures after waiting at least 30 minutes.
5. Unless otherwise specified, prepare the most suitable reception or input signal for adjustment.
6. Never touch any adjustment parts, which are not specified in the list for this adjustment-variable resistors, transformers, capacitors, etc.
7. Presetting before adjustment.

Unless otherwise specified in the adjustment instructions, preset the following functions with the remote control unit.

- User mode setting position

VIDEO STATUS	STANDARD
HYPER SURROUND	OFF
BASS, TREBLE, BALANCE	CENTER
TINT, COLOR, PICTURE, BRIGHT, DETAIL	CENTER

MEASURING INSTRUMENT

1. DC voltmeter(or digital voltmeter)
2. Oscilloscope
3. Signal generator (Pattern generator) [NTSC]
4. Remote control unit
5. TV audio multiplex signal generator
6. Frequency counter
7. Resistor (1M Ω)

ADJUSTMENT ITEMS

- Check of B1 POWER SUPPLY
- RF AGC adjustment
- TU2 VCO adjustment [Only for AV-32260]
- FOCUS adjustment
- WHITE BALANCE adjustment
 - WHITE BALANCE (Low Light) adjustment
 - WHITE BALANCE (High Light) adjustment
 - PIP HIGH LIGHT WHITE BALANCE adjustment [Only for AV-32260]
- BRIGHT adjustment
 - SUB BRIGHT adjustment
- CONTRAST adjustment
 - SUB CONTRAST adjustment
- DEFLECTION adjustment
 - V POSITION and V SIZE adjustment
 - H SIZE and H POSITION adjustment
 - SIDE PIN and CORNER PIN adjustment
 - PIP DISPLAY POSITION adjustment [Only for AV-32260]
- CHROMA adjustment
 - SUB COLOR adjustment
 - SUB TINT adjustment
- MTS circuit adjustment
 - INPUT LEVEL check
 - STEREO VCO adjustment
 - SAP VCO adjustment
 - FILTER check
 - SEPARATION adjustment
- PURITY and CONVERGENCE adjustments
 - PURITY adjustment
 - STATIC CONVERGENCE adjustment
 - DYNAIC CONVERGENCE adjustment

BASIC OPERATION OF SERVICE MENU

1. TOOL OF SERVICE MENU OPERATION

Operate the SERVICE MENU with the REMOTE CONTROL UNIT.

2. SERVICE MENU ITEMS

In general, basic setting (adjustments) items or verifications are performed in the SERVICE MENU.

- PICTURE This sets the setting values (adjustment values) of the VIDEO/CHROMA and DEFLECTION circuits.
- SOUND This sets the setting values (adjustment values) of the AUDIO circuit.
- THEATER This is used when the THEATER MODE is adjusted.
- OTHERS This is used when the OTHERS MODE is adjusted.
- PIP This sets the setting values (adjustment values) of the PIP circuit. **[Only for AV-32260]**
- LOW LIGHT This sets the setting values (adjustment values) of the WHITE BALANCE circuit.
- HIGH LIGHT This sets the setting values (adjustment values) of the WHITE BALANCE circuit.
- RF AFC This is used when the RF AFC MODE is verified. **[Do not adjust/Only for AV-32230]**
- RF AFC1 This is used when the RF AFC1 MODE is verified. **[Do not adjust/Only for AV-32260]**
- RF AFC2 This is used when the RF AFC2 MODE is verified. **[Do not adjust/Only for AV-32260]**
- TU2 VCO This is used when the TV2 VCO MODE is adjusted. **[Only for AV-32260]**
- I2C BUS CTRL This is used when ON/OFF of the I2C BUS CTRL is set. **[Fixed ON]**

3. Basic Operations of the SERVICE MENU

(1) How to enter the SERVICE MENU

Press **SLEEP TIMER** key and, while the indication of "SLEEP TIMER 0 MIN." is being displayed, press **DISPLAY** key and **VIDEO STATUS** key on the remote control unit simultaneously to enter the **SERVICE MENU** screen ① shown in the next figure page.

(2) SERVICE MENU screen selection

Press the UP / DOWN key of the MENU to select any of the following items.

(The letters of the selected items are displayed in yellow.)

[AV-32230]

- PICTURE
- THEATER
- SOUND
- OTHERS
- LOW LIGHT
- RF AFC
- HIGH LIGHT
- I2C BUS CTRL

[AV-32260]

- PICTURE
- THEATER
- PIP
- LOW LIGHT
- RF AFC1
- TU2 VCO
- SOUND
- OTHERS
- HIGH LIGHT
- RF AFC2
- I2C BUS CTRL

(3) Enter the any setting (adjustment) mode

● PICTURE, SOUND and OTHERS mode

- 1) If select any of PICTURE, SOUND or OTHERS items, and the LEFT / RIGHT key is pressed from SERVICE MENU (MAIN MENU), the screen ② will be displayed as shown in figure page later.
- 2) Then the UP / DOWN key is pressed, the PICTURE mode screen ③ or the SOUND mode screen ④ or the OTHER mode screen ⑤ is displayed, and the PICTURE, SOUND or OTHERS setting can be performed.

● PIP mode [Only for AV-32260]

- 1) If select the PIP item, and the LEFT/RIGHT key is pressed from SERVICE MENU (MAIN MENU), the screen ⑥ will be displayed as shown in figure page later.
- 2) Then the UP/DOWN key is pressed, the PIP mode screen ⑦ is displayed, and the PIP setting can be performed.

[AV-32230]

● THEATER, LOW LIGHT, HIGH LIGHT, RF AFC and I2C BUS CTRL mode

- 1) If select any of THEATER / LOW LIGHT / HIGH LIGHT / RF AFC / I2C BUS CTRL items, and the LEFT / RIGHT key is pressed from SERVICE MENU (MAIN MENU), the screens ⑧ ⑨ ⑩ ⑪ ⑫ will be displayed as shown in figure page later.
- 2) Then the settings or verifications can be performed.

[AV-32260]

● THEATER, LOW LIGHT, HIGH LIGHT, RF AFC1, RF AFC2, TU2 VCO and I2C BUS CTRL mode

- 1) If select any of THEATER / LOW LIGHT / HIGH LIGHT / RF AFC1 / RF AFC2 / TU2 VCO / I2C BUS CTRL items, and the LEFT / RIGHT key is pressed from SERVICE MENU (MAIN MENU), the screens ⑧ ⑨ ⑩ ⑪ ⑫ ⑬ ⑭ ⑮ will be displayed as shown in figure page later.
- 2) Then the settings or verifications can be performed.

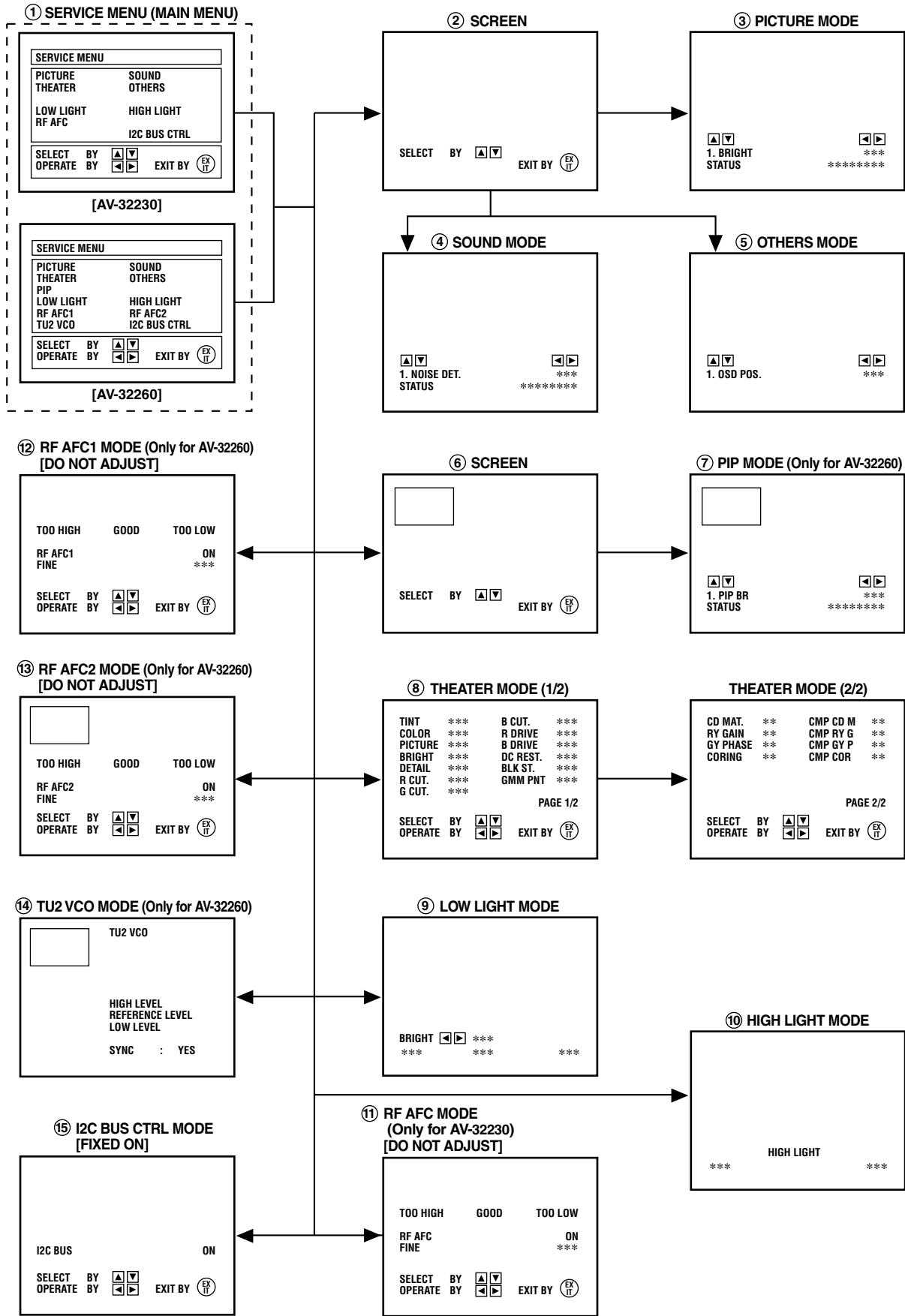

(4) Setting method

- 1) UP / DOWN key of the MENU
Select the SETTING ITEM.
- 2) LEFT / RIGHT key of the MENU
Setting (adjust) the SETTING VALUE of the SETTING ITEM.
When the key is released the SETTING VALUE will be stored (memorized).
- 3) EXIT key
Returns to the previous screen.

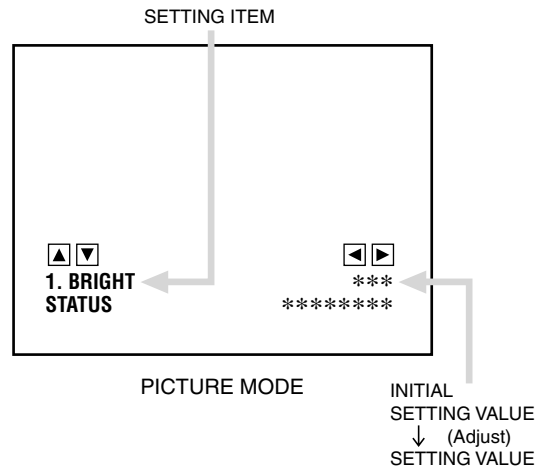

(5) Releasing SERVICE MENU

- 1) After returning to the SERVICE MENU upon completion of the setting (adjustment) work, press the EXIT key again.

★ The settings for LOW LIGHT and HIGH LIGHT are described in the WHITE BALANCE page of ADJUSTMENT.

ADJUSTMENT LOCATIONS

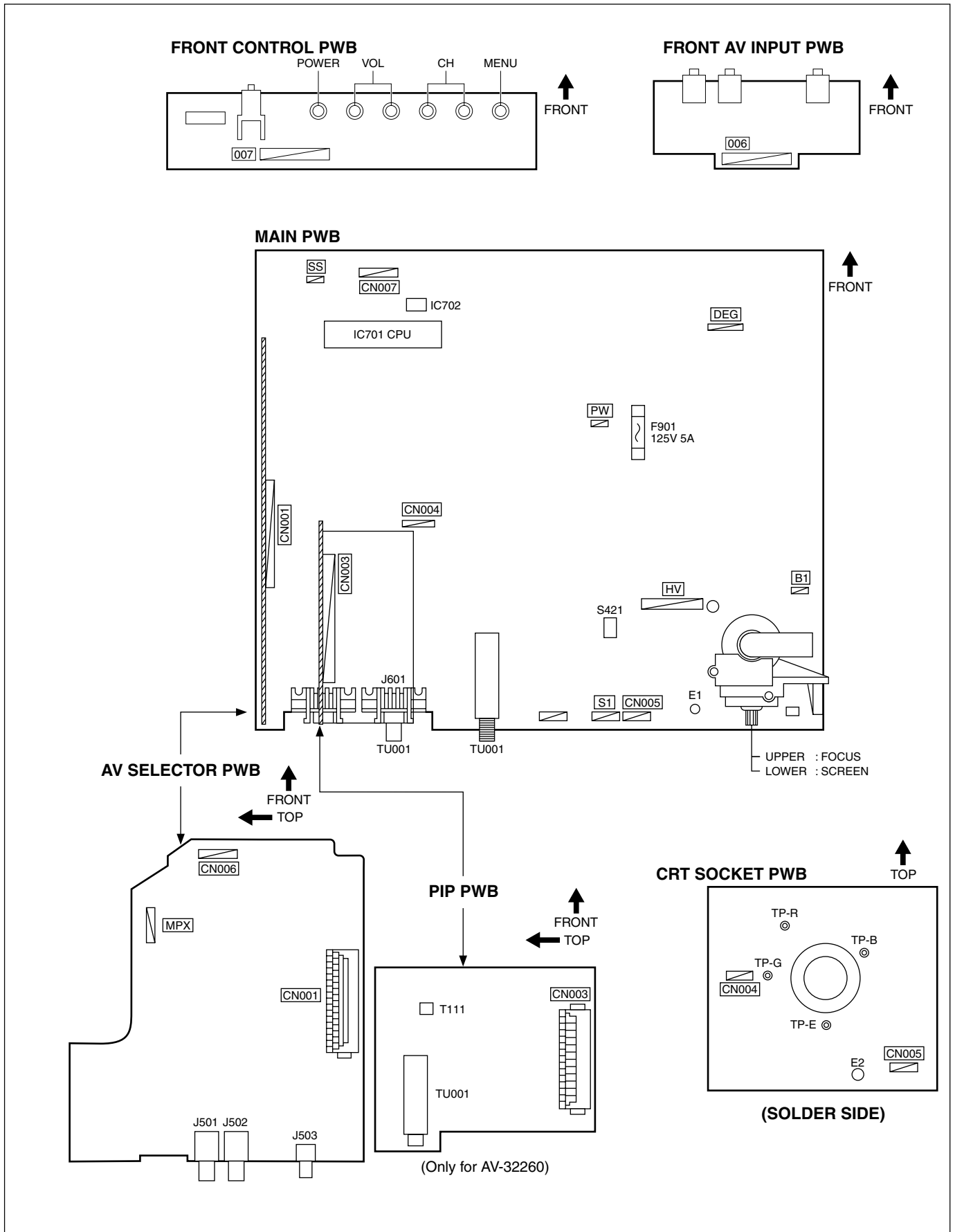

INITIAL SETTING VALUE OF SERVICE MENU

1. Adjustment of the SERVICE MENU is made on the basis of the initial setting values; however, the new setting values which set the screen in its optimum condition may differ from the initial setting.
2. Do not change the initial setting values of the setting (Adjustment) items not listed in "ADJUSTMENT".

● PICTURE MODE

☆ The four setting items in the video mode No.6 EXT BRI., No.7 EXT PIC., No.8 EXT COL. and No.9 EXT TINT are linked to the items in the TV MODE No.1 BRIGHT, No.2 PICTURE, No.3 COLOR and No.4 TINT, respectively. When the setting items in the TV mode are adjusted, the values in the setting items in the video mode are revised automatically to the same values in the TV mode.(The initial setting values given in () are off-set values.)

☆ When the four items (No.6, 7, 8 and 9) are adjusted in the video mode, the setting values in each item are revised independently.

No.	Setting (Adjustment) item	Variable range	Initial setting value	Remark
1	BRIGHT	000 — 127	063	
2	PICTURE	000 — 127	085	
3	COLOR	000 — 127	072	
4	TINT	000 — 127	065	
5	TV DETAIL	000 — 063	055	
6	EXT BRIGHT	±025	±000	
7	EXT PICT.	±025	+006	
8	EXT COLOR	±025	-006	
9	EXT TINT	±025	±000	
10	EXT DETAIL	000 — 063	050	
11	CMP BRIGHT	±025	±000	
12	CMP PICT.	±025	+006	
13	CMP COLOR	000 — 127	086	
14	CMP TINT	000 — 127	064	
15	CMP DETAIL	000 — 063	050	
16	CMP R CUT	±025	-011	
17	CMP G CUT	±025	±000	
18	CMP B CUT	±025	-001	
19	CMP R DRV	±025	±000	
20	CMP B DRV	±025	±000	
21	WPL	000 / 001	001	
22	B. B. SW	000 / 001	000	
23	C TRAP	000 / 001	000	
24	CORING	000 / 001	000	
25	CMP CORING	000 / 001	001	
26	TV SHARPF	000 / 001	001	
27	EXT SHARPF	000 / 001	001	
28	CMP SHARPF	000 / 001	001	
29	RGB CONT	000 — 063	031	
30	TV ID SENS	000 / 001	000	
31	EXT ID SEN	000 / 001	001	
32	F ID	000 / 001	000	
33	Y MUTE	000 / 001	000	
34	AUDIO ATT	000 — 127	127	
35	SUB CONT	000 — 015	010	
36	R Y GAIN	000 / 001	001	
37	CMP R Y GA	000 / 001	001	
38	G Y PHASE	000 / 001	000	
39	CMP G Y PH	000 / 001	000	
40	CD MATRIX	000 — 003	003	
41	CMP CD MAT	000 — 003	002	
42	BLACK ST	000 — 003	001	
43	DC REST	000 — 003	001	
44	COLOR GMM	000 / 001	000	
45	UV/CBCR	000 / 001	001	

No.	Setting (Adjustment) item	Variable range	Initial setting value	Remark
46	AT FLESH	000 / 001	000	
47	ABL GAIN	000 — 003	000	
48	ABL ST PNT	000 — 003	003	
49	RGB ABCL	000 / 001	001	
50	TV BPF TOF	000 / 001	001	
51	EXT BPF TOF	000 / 001	000	
52	GMM PNT	000 — 003	003	
53	SVM GAIN	000 — 003	003	
54	CMP SVM GA	000 — 003	003	
55	SVM PHASE	000 / 001	000	
56	AUDIO SW	000 / 001	000	
57	BUZZ	000 / 001	000	
58	IF FREQ	000 / 001	000	
59	RF AGC	000 — 063	045	
60	AFT MUTE	000 / 001	000	
61	AFT SENS	000 / 001	001	
62	R/G DRV SW	000 / 001	001	
63	BLK SW	000 / 001	000	
64	V S COR	000 — 015	009	AV-32230/AG & AH, AV32260/AG & AH
	V S COR	000 — 015	008	AV-32230/AM & AR, AV32260/AM & AR
65	V LIN	000 — 015	011	
66	V SIZE	000 — 127	072	AV-32230/AG, AV32260/AG
	V SIZE	000 — 127	067	AV-32230/AH, AV32260/AH
	V SIZE	000 — 127	065	AV-32230/AM & AR, AV32260/AM & AR
67	V AGC	000 / 001	000	
68	V CENTER	000 — 063	000	
69	TV AFC	000 — 003	000	
70	EXT AFC	000 — 003	002	
71	V POSI	000 — 007	000	
72	H POSI	000 — 031	018	
73	H SIZE	000 — 063	028	AV-32230/AG & AH, AV32260/AG & AH
	H SIZE	000 — 063	017	AV-32230/AM, AV32260/AM
	H SIZE	000 — 063	023	AV-32230/AR, AV32260/AR
74	TV V FREQ	000 — 003	000	
75	EXT V FREQ	000 — 003	003	
76	SIDE PIN	000 — 063	040	AV-32230/AG, AV32260/AG
	SIDE PIN	000 — 063	034	AV-32230/AH, AV32260/AH
	SIDE PIN	000 — 063	055	AV-32230/AM, AV32260/AM
	SIDE PIN	000 — 063	027	AV-32230/AR, AV32260/AR
77	STAND BY	000 / 001	000	
78	TRAPEZ	000 — 063	032	AV-32230/AG, AV32260/AG
	TRAPEZ	000 — 063	038	AV-32230/AH & AM, AV32260/AH & AM
	TRAPEZ	000 — 063	035	AV-32230/AR, AV32260/AR
79	V RAMP REF	000 / 001	001	
80	V 48HZ	000 / 001	000	
81	V EHT	000 — 007	000	
82	TOP PIN	000 — 031	011	AV-32230/AG & AM, AV32260/AG & AM
	TOP PIN	000 — 031	013	AV-32230/AH, AV32260/AH
	TOP PIN	000 — 031	010	AV-32230/AR, AV32260/AR
83	H EHT	000 — 007	000	
84	BTM PIN	000 — 031	014	AV-32230/AG & AM, AV32260/AG & AM
	BTM PIN	000 — 031	019	AV-32230/AH, AV32260/AH
	BTM PIN	000 — 031	012	AV-32230/AR, AV32260/AR
85	V BLK LOW	000 — 003	000	

No.	Setting (Adjustment) item	Variable range	Initial setting value	Remark
86	V BLK UP	000 — 003	000	
87	CAPTION IN	000 / 001	000	
88	H BLK	000 / 001	000	
89	SCREEN	000 / 001	000	
90	ACB SW	000 / 001	000	
91	ACB PULSE	000 — 015	007	
92	OVER MODU	000 / 001	001	
93	APACON LIM	000 / 001	001	
94	TEST	000 — 255	128	
95	RF S/N TY	000 — 002	002	
96	EXT S/N TY	000 — 002	002	
97	RF SN YC E	000 — 255	005	
98	RF SN YC F	000 — 255	016	
99	RF SN YC G	000 — 063	032	
100	RF SN YC H	000 — 255	025	
101	EX SN YC E	000 — 255	005	
102	EX SN YC F	000 — 255	016	
103	EX SN YC G	000 — 063	032	
104	EX SN YC H	000 — 255	025	
105	RF SN VC 1	000 — 063	000	
106	RF SN VC 2	000 — 063	007	
107	RF SN VC 3	000 — 063	014	
108	RF SN VC 4	000 — 063	021	
109	EX SN VC 1	000 — 063	000	
110	EX SN VC 2	000 — 063	007	
111	EX SN VC 3	000 — 063	014	
112	EX SN VC 4	000 — 063	021	
113	COR LEVEL	000 — 003	003	
114	VNR CHK	000 — 255	003	
115	YC SN TIME	000 — 255	005	
116	VC SN TIME	000 — 255	005	
117	VM DATA A	±127	+008	
118	VM DATA B	±127	-004	
119	VM DATA C	±127	-016	
120	VM DATA D	000 / 001	000	
121	VC SN STOP	000 — 255	002	
122	CH MUTE	00/001	000	
123	VM OFF TY	000/001	000	
124	VC VM OFF	000/001	001	
125	YC VM OFF	000 — 255	255	
126	F LOCK	000 — 002	002	
127	VF LOCK EX	000/001	000	
128	PURI RGB	000 — 063	031	
129	PURI BCK	000/001	000	

● SOUND MODE

No.	Setting (Adjustment) item	Variable range	Initial setting value	Remark
1	NOISE DET.	000 / 001	001	
2	IN LEVEL	000 — 063	025	
3	FH MONITOR	000 / 001	000	
4	STEREO VCO	000 — 063	030	
5	PILOT CAN.	000 / 001	000	
6	FILTER	000 — 063	030	
7	LOW SEP.	000 — 063	028	
8	HI SEP.	000 — 063	025	
9	5FH MON.	000 / 001	000	
10	SAP VCO	000 — 063	003	
11	IN GAIN	000 / 001	000	
12	FIL. OFFSET	±010	±000	
13	BBE BASS	±010	±000	
14	BBE TRE	±010	+002	

● THEATER MODE

Setting (Adjustment) item	Variable range	Initial setting value	Remark
TINT	±20	-06	
COLOR	±20	-03	
PICTURE	±50	-15	
BRIGHT	±20	±00	
DETAIL	±20	+03	
R CUT.	±20	±00	
G CUT.	±20	±00	
B CUT.	±20	±00	
R DRIVE	±99	+07	
B DRIVE	±99	-25	
DC REST.	00 — 03	01	
BLK ST.	00 — 03	00	
GMM PNT	00 — 03	01	
CD MAT.	00 — 03	01	
RY GAIN	00 / 01	01	
GY PHASE	00 / 01	00	
CORING	00 / 01	01	
CMP CD M	00 — 03	01	
CMP RY G	00 / 01	01	
CMP GY P	00 / 01	00	
CMP COR	00 / 01	01	

● OTHERS MODE

No.	Setting (Adjustment) item	Variable range	Initial setting value	Remark
1	OSD POS.	000 — 007	002	
2	CCD POS.	000 — 015	003	
3	EOSEL	000 / 001	000	
4	MENU COLOR	000 — -030	-010	
5	MENU PICT.	000 — -030	-010	
6	MENU BRI.	000 — -030	-010	

● PIP MODE [Only for AV-32260]

No.	Setting (Adjustment) item	Variable range	Initial setting value	Remark
1	PIP BR	000 — 015	004	
2	PIP PICT	030 — 045	045	
3	PIP TINT	000 — 063	036	
4	PIP COL	000 — 015	010	
5	P R CUT	000 — 015	003	
6	P G CUT	000 — 015	000	
7	P B CUT	000 — 015	002	
8	P R DR	000 — 255	052	
9	P G DR	000 — 255	055	
10	P B DR	000 — 255	060	
11	LEFT POS.	000 — 255	020	
12	RIGHT POS.	000 — 255	017	
13	UPPER POS.	000 — 127	012	
14	LOWER POS.	000 — 127	011	
15	PICT LOCK	000 / 001	001	
16	SELDEL	000 — 015	000	
17	AGCFIX	000 / 001	001	
18	AGCADST	000 / 001	000	
19	AGC	000 — 015	007	
20	VSPDEL	000 — 031	000	
21	VSPISQ	000 / 001	001	
22	YCOR	000 / 001	001	
23	XFREQF	000 / 001	001	
24	WTCHDG	000 / 001	001	
25	COLON	000 / 001	000	
26	ACQNEW	000 / 001	000	
27	DSTDET	000 / 001	001	
28	CRIBEOK	000 / 001	000	
29	FCBEOK	000 / 001	000	
30	NOCRID	000 / 001	000	
31	NONSED	000 / 001	000	

● **LOW LIGHT MODE**

Setting (Adjustment) item	Variable range	Initial setting value	Remark
R CUTOFF	0 — 255	085	
G CUTOFF	0 — 255	085	
B CUTOFF	0 — 255	085	

● **HIGH LIGHT MODE**

Setting (Adjustment) item	Variable range	Initial setting value	Remark
R DRIVE	0 — 127	060	
B DRIVE	0 — 127	060	

● **RF AFC MODE [Only for AV-32230]**

Setting (Adjustment) item	Variable range	Initial setting value	Remark
RF AFC	ON / OFF	ON	(DO NOT ADJUST)
FINE	-77 — +77	± × ×	

● **RF AFC1 MODE [Only for AV-32260]**

Setting (Adjustment) item	Variable range	Initial setting value	Remark
RF AFC1	ON / OFF	ON	(DO NOT ADJUST)
FINE	-77 — +77	± × ×	

● **RF AFC2 MODE [Only for AV-32260]**

Setting (Adjustment) item	Variable range	Initial setting value	Remark
RF AFC2	ON / OFF	ON	(DO NOT ADJUST)
FINE	-77 — +77	± × ×	

● **I2C BUS CTRL MODE**

Setting (Adjustment) item	Variable range	Initial setting value	Remark
I2C BUS	ON/OFF	[FIXED ON]	(DO NOT ADJUST)

ADJUSTMENTS

B1 POWER SUPPLY

Item	Measuring instrument	Test point	Adjustment part	Description
Check of B1 POWER SUPPLY	DC Voltmeter	B1 (pin 1) GND (pin 3) [B1 connector in MAIN PWB]		<ol style="list-style-type: none"> 1. Receive a black-and-white signal. 2. Connect the DC Voltmeter between B1 and GND (between pins 1 and 3 of the B1 connector). 3. Confirm that the voltage is DC134V^{+2V}_{-2V}.

ADJUSTMENT OF RF AGC

Item	Measuring instrument	Test point	Adjustment part	Description
RF AGC adjustment	Remote control unit		No.59 RF AGC	<ol style="list-style-type: none"> 1. Receive a broadcast. 2. Select the No.59 RF AGC of the PICTURE MODE. 3. Press the MUTE key of the remote control unit to turn off color. 4. With the LEFT key of the remote control unit, get noise in the screen picture. (0 side of setting value) 5. Press the RIGHT key of the remote control unit and stop when noise disappears from the screen. 6. Change to other channels and make sure that there is no irregularity. 7. Press the MUTE key and get color out.

ADJUSTMENT OF TU2 VCO

Item	Measuring instrument	Test point	Adjustment part	Description
TU2 VCO adjustment [AV-32260]	Remote control unit		T111 (CW TRANSF) [PIP PWB]	<ol style="list-style-type: none"> 1. Receive a broadcast. 2. Select the TU2 VCO MODE from the SERVICE MENU. 3. Confirm "SYNC" is "YES". 4. Turn the T111 (CW TRANSF) until "REFERENCE LEVEL" characters become yellow. 5. Confirm "SYNC" is "YES" again.

TU2 VCO

HIGH LEVEL
REFERENCE LEVEL ← YELLOW

LOW LEVEL

SYNC : YES

ADJUSTMENT OF FOCUS

Item	Measuring instrument	Test point	Adjustment part	Description
FOCUS adjustment	Signal generator		FOCUS VR [In HVT] H VR [In HVT]	<p>Notes:</p> <ul style="list-style-type: none"> • Proceed to the following this adjustment after having completed the adjustments of B1 POWER SUPPLY, SUB BRIGHT and PICTURE. • Set VIDEO STATUS to "STANDARD". • The final adjustment of CONVERGENCE must be done after the FOCUS adjustment. (CONVERGENCE is changed by FOCUS adjustment.) When makes difference by FOCUS adjustment, should be reconfirming PURITY adjustment. <ol style="list-style-type: none"> 1. Receive a crosshatch signal. 2. While looking at the screen center, adjust the FOCUS VR so that the horizontal lines will be clear and in fine detail. 3. Adjust the H VR so that the vertical lines will be clear and in fine detail. 4. Make sure that the picture is in focus even when the screen gets darkened.

ADJUSTMENT OF WHITE BALANCE

Item	Measuring instrument	Test point	Adjustment part	Description
<p>WHITE BALANCE (Low Light) adjustment</p>	<p>Signal generator Remote control unit</p>		<p>No.1 BRIGHT R CUTOFF G CUTOFF B CUTOFF SCREEN VR [In HVT]</p>	<p>Note : Set VIDEO STATUS to "STANDARD".</p> <ol style="list-style-type: none"> 1. Receive a black-and-white signal.(Color off) 2. Select the [LOW LIGHT] MODE from the SERVICE MENU. 3. Set the initial setting value of BRIGHT is 063 with the LEFT / RIGHT key of the remote control unit. 4. Set the initial setting value of R CUTOFF, G CUTOFF and B CUTOFF is 085 with the ④ to ⑨ key of the remote control unit. 5. Display a single horizontal line by pressing the ① key of the remote control unit. 6. Turn the screen VR all the way to the left. 7. Turn the screen VR gradually to the right from the left until either one of the red, blue or green colors appears faintly. 8. Adjust the two colors which did not appear until the single horizontal line that is displayed becomes white using the ④ to ⑨ keys of the remote control unit. 9. Turn the screen VR to where the single horizontal line glows faintly. 10. Press the ② key to return to the regular screen. <p>* The ③ EXIT key is the cancel key for the WHITE BALANCE.</p>
<p>WHITE BALANCE (High Light) adjustment</p>	<p>Signal generator Remote control unit</p>		<p>R DRIVE B DRIVE</p>	<p>Notes:</p> <ul style="list-style-type: none"> • Proceed to the following this adjustment after having completed the adjustment of LOW LIGHT WHITE BALANCE. • Set VIDEO STATUS to "STANDARD". <ol style="list-style-type: none"> 1. Receive a black-and-white signal. (Color off) 2. Select the [HIGH LIGHT] MODE from the SERVICE MENU. 3. Set the initial setting value of R DRIVE and B DRIVE is 060 with the ④, ⑥, ⑦ and ⑨ keys of the remote control unit. 4. Adjust the screen until it becomes white using the ④, ⑥, ⑦ and ⑨ keys of the remote control unit. <p>* The ③ (EXIT) key is the cancel key for the WHITE BALANCE.</p>

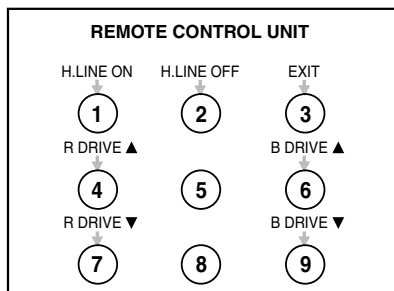
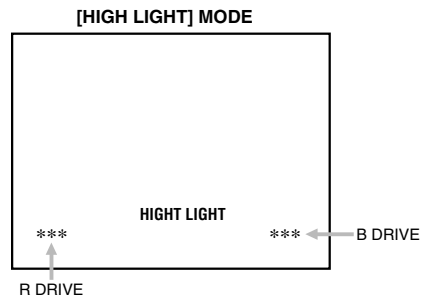
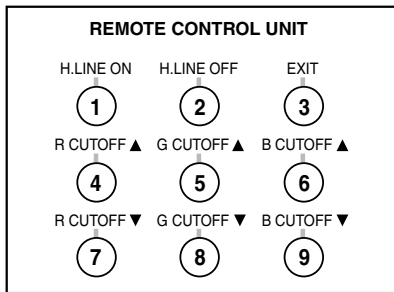
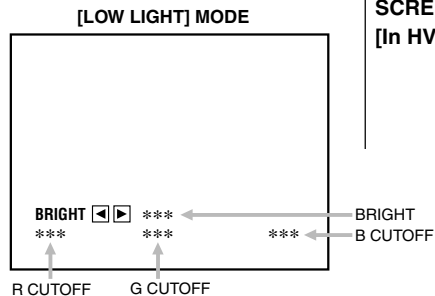

Item	Measuring instrument	Test point	Adjustment part	Description
PIP HIGH LIGHT WHITE BALANCE adjustment [AV-32260]	Signal generator Remote control unit		No.8 P R DR No.10 P B DR	<p>Notes:</p> <ul style="list-style-type: none"> • Proceed to the following this adjustment after having completed the adjustments of LOW LIGHT WHITE BALANCE and HIGH LIGHT WHITE BALANCE for the main picture. • Set VIDEO STATUS to "STANDARD". <ol style="list-style-type: none"> 1. Receive a black-and-white signal. (Color off) 2. Select the PIP MODE from the SERVICE MENU. 3. Then adjust the white color of the PIP screen using the No. 8 P R DR and the No. 10 P B DR of the PIP MODE so that it is the same brightness as the main screen.

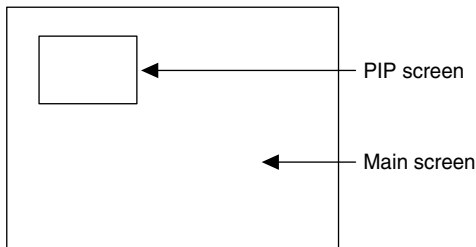

ADJUSTMENT OF BRIGHT

Item	Measuring instrument	Test point	Adjustment part	Description
SUB BRIGHT adjustment	Remote control unit		No.1 BRIGHT	<p>Notes:</p> <ul style="list-style-type: none"> • Proceed to the following this adjustment after having completed the adjustments of LOW LIGHT WHITE BALANCE and HIGH LIGHT WHITE BALANCE. • Set VIDEO STATUS to "STANDARD". <ol style="list-style-type: none"> 1. Receive a broadcast. 2. Select the No.1 BRIGHT of the PICTURE MODE. 3. Set the initial setting value of the No.1 BRIGHT with the LEFT / RIGHT key of the remote control unit. 4. If the brightness is not best with the initial setting value, make fine adjustment of the No.1 BRIGHT until you get the optimum brightness.

ADJUSTMENT OF CONTRAST

Item	Measuring instrument	Test point	Adjustment part	Description
SUB CONTRAST adjustment	Remote control unit		No.2 PICTURE	<p>Notes:</p> <ul style="list-style-type: none"> • Proceed to the following this adjustment after having completed the adjustment of SUB BRIGHT. • Set VIDEO STATUS to "STANDARD". <ol style="list-style-type: none"> 1. Receive a broadcast. 2. Select the No.2 PICTURE of the PICTURE MODE. 3. Set the initial setting value of the No.2 PICTURE with the LEFT / RIGHT key of the remote control unit. 4. If the contrast is not best with the initial setting value, make fine adjustment of the No.2 PICTURE until you get the optimum contrast.

ADJUSTMENT OF DEFLECTION

Item	Measuring instrument	Test point	Adjustment part	Description
<p>V POSITION and V SIZE adjustment</p>	<p>Signal generator Remote control unit</p>		<p>No.71 V POSI No.66 V SIZE S1421 (V CENTER SW) [MAIN PWB]</p>	<p>Note: Proceed to the following this adjustment after having completed the adjustments of SUB BRIGHT and SUB CONTRAST.</p> <ol style="list-style-type: none"> 1. Receive a crosshatch signal with circle pattern. 2. Select the No. 71 V POSI of the PICTURE MODE. 3. Confirm the value of No. 71 V POSI is "0". 4. Switch the S1421 (V CENTER SW) so that a crosshatch signal become to the center of CRT. 5. Select the No.66 V SIZE of the PICTURE MODE to squeeze the raster. 6. Adjust the No.66 V SIZE until the vertical screen size is 92%.
<p>H SIZE and H POSITION adjustment</p>	<p>Signal generator Remote control unit</p>		<p>No.73 H SIZE No.72 H POSI</p>	<p>Note: Proceed to the following this adjustment after having completed the adjustments of FOCUS, SUB BRIGHT, SUB CONTRAST, V POSITION and V SIZE.</p> <ol style="list-style-type: none"> 1. Receive a crosshatch signal. 2. Select the No.73 H SIZE of the PICTURE MODE. 3. Set the initial setting value of the No.73 H SIZE with the LEFT / RIGHT key of the remote control unit. 4. Adjust the No.73 H SIZE until the horizontal screen size is 92%. 5. Adjust the No.72 H POSI until the screen will be horizontally centered.

Item	Measuring instrument	Test point	Adjustment part	Description
SIDE PIN and CORNER PIN adjustment	Signal generator Remote control unit		No.76 SIDE PIN No.82 TOP PIN No.84 BTM PIN	<p>Note: Proceed to the following this adjustment after having completed the adjustments of FOCUS, SUB BRIGHT, SUB CONTRAST, V CENTER, V POSITION and V SIZE.</p> <ol style="list-style-type: none"> 1. Receive a crosshatch signal. 2. Adjust such that vertical 2nd lines from left and right to be straight at the No.76 SIDE PIN of the PICTURE MODE. 3. Adjust the end of vertical 2nd lines from left and right to be straight at the No.82 TOP PIN and the No.84 BTM PIN of the PICTURE MODE.
PIP DISPLAY POSITION adjustment [AV-32260]	Remote control unit		No.11 LEFT POS. No.12 RIGHT POS. No.13 UPPER POS. No.14 LOWER POS.	<p>Notes:</p> <ul style="list-style-type: none"> • Proceed to the following this adjustment after having completed the adjustments of V POSITION, V SIZE, H SIZE, H POSITION, SIDE PIN and CORNER PIN for the main picture. • Set VIDEO STATUS to "STANDARD". <ol style="list-style-type: none"> 1. Receive a broadcast. 2. Select the PIP MODE from the SERVICE MENU. 3. Then adjust the PIP screen size so that it occupies 80% ± 2% of the main screen area.

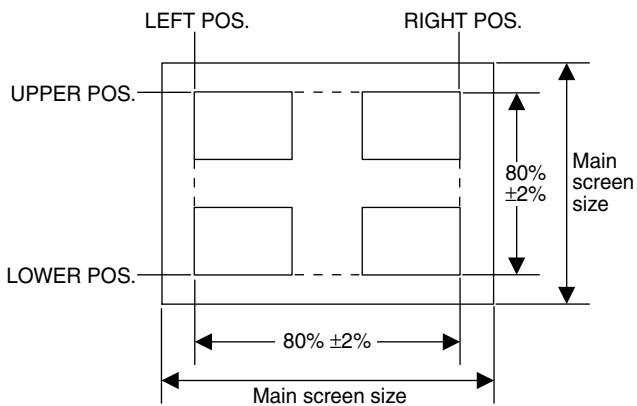
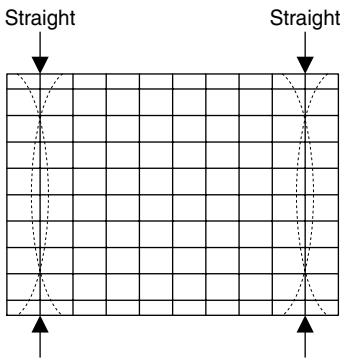

ADJUSTMENT OF CHROMA

Item	Measuring instrument	Test point	Adjustment part	Description								
SUB COLOR adjustment	Signal generator	TP-B TP-E (\overline{TT}) [CRT SOCKET PWB]	No.3 COLOR	<p>Notes:</p> <ul style="list-style-type: none"> Proceed to the following this adjustment after having completed the adjustment of CONTRAST. Set VIDEO STATUS to "STANDARD". <p>[Method of adjustment without measuring instrument]</p> <ol style="list-style-type: none"> Receive a broadcast. Select the No.3 COLOR of the PICTURE MODE. Set the initial setting value of the No.3 COLOR with the LEFT/RIGHT key of the remote control unit. If the color is not the best with the Initial setting value, make fine adjustment of the No.3 COLOR until you get the optimum color. 								
	Oscilloscope											
	Remote control unit											
<table border="1"> <thead> <tr> <th>Model</th> <th>A (Vw-B)</th> </tr> </thead> <tbody> <tr> <td>AV-32230/AG & AR, AV-32260/AG & AR</td> <td>+12V</td> </tr> <tr> <td>AV-32230/AH, AV-32260/AH</td> <td>+18V</td> </tr> <tr> <td>AV-32230/AM, AV-32260/AM</td> <td>+17V</td> </tr> </tbody> </table>					Model	A (Vw-B)	AV-32230/AG & AR, AV-32260/AG & AR	+12V	AV-32230/AH, AV-32260/AH	+18V	AV-32230/AM, AV-32260/AM	+17V
Model	A (Vw-B)											
AV-32230/AG & AR, AV-32260/AG & AR	+12V											
AV-32230/AH, AV-32260/AH	+18V											
AV-32230/AM, AV-32260/AM	+17V											
Table 1												
SUB TINT adjustment	Signal generator	TP-B TP-E (\overline{TT}) [CRT SOCKET PWB]	No.4 TINT	<p>Notes:</p> <ul style="list-style-type: none"> Proceed to the following this adjustment after having completed the adjustment of CONTRAST. Set VIDEO STATUS to "STANDARD". <p>[Method of adjustment without measuring instrument]</p> <ol style="list-style-type: none"> Receive a broadcast. Select the No.4 TINT of the PICTURE MODE. Set the initial setting value of the No.4 TINT with the LEFT/RIGHT key of the remote control unit. If the tint is not the best with the initial setting value, make fine adjustment of the No.4 TINT until you get the optimum tint. 								
	Oscilloscope											
	Remote control unit											
<table border="1"> <thead> <tr> <th>Model</th> <th>B (Vw-Mg)</th> </tr> </thead> <tbody> <tr> <td>AV-32230/AG & AH, AV-32260/AG & AH</td> <td>+16V</td> </tr> <tr> <td>AV-32230/AM, AV-32260/AM</td> <td>+14V</td> </tr> <tr> <td>AV-32230/AR, AV-32260/AR</td> <td>+12V</td> </tr> </tbody> </table>					Model	B (Vw-Mg)	AV-32230/AG & AH, AV-32260/AG & AH	+16V	AV-32230/AM, AV-32260/AM	+14V	AV-32230/AR, AV-32260/AR	+12V
Model	B (Vw-Mg)											
AV-32230/AG & AH, AV-32260/AG & AH	+16V											
AV-32230/AM, AV-32260/AM	+14V											
AV-32230/AR, AV-32260/AR	+12V											
Table 2												

ADJUSTMENT OF MTS CIRCUIT

Item	Measuring instrument	Test point	Adjustment part	Description
MTS INPUT LEVEL check	Remote control unit		No.2 IN LEVEL	<ol style="list-style-type: none"> 1. Select the No.2 IN LEVEL of the SOUND MODE. 2. Verify that the No.2 IN LEVEL is set at its initial setting value.
MTS STEREO VCO adjustment	Signal generator Frequency counter Remote control unit	2 pin AUDIO R 3 pin GND [MPX Connector in AV SELECTOR PWB]	No.3 FH MONITOR No.4 STEREO VCO	<p>Note: Menu "MTS" is set to "STEREO"</p> <ol style="list-style-type: none"> 1. Receive a RF signal (nonmodulated sound signal) from the antenna terminal. 2. Select the No.3 FH MONITOR of SOUND MODE, and change the setting value from 0 to 1. 3. Connect the Frequency Counter to pin 2 of [MPX] connector and GND (Pin 3 of [MPX] connector). 4. Select the No.4 STEREO VCO. 5. Set the initial setting value of the No.4 STEREO VCO with the LEFT/RIGHT key of the remote control unit. 6. Adjust the No.4 STEREO VCO so that the frequency counter will display 15.73kHz±0.1kHz. 7. Select the No.3 FH MONITOR of the SOUND MODE, and reset the setting value from 1 to 0.
MTS SAP VCO adjustment	Signal generator Frequency counter Remote control unit	4 pin TP_952.5 3 pin GND 2 pin AUDIO_R [MPX Connector in AV SELECTOR PWB]	No.9 5FH MON. No.10 SAP VCO	<ol style="list-style-type: none"> 1. Receive a RF signal (non modulated sound signal) from the antenna terminal. 2. Connect between pin 4 of [MPX] connector and GND (Pin 3 of [MPX] connector) through 1MΩ Resistor. 3. Select the No.9 5FH MON. of the SOUND MODE, and reset the setting value from 0 to 1. 4. Connect the Frequency Counter to pin 2 of [MPX] connector and GND (Pin 3 of [MPX] connector) . 5. Select the No.10 SAP VCO. 6. Set the initial setting value of the No.10 SAP VCO with the LEFT/RIGHT key of the remote control unit. 7. Adjust the No.10 SAP VCO so that the frequency counter will display 78.67kHz±0.5kHz. 8. Select the No.9 5FH MON. of the SOUND MODE, and reset the setting value from 1 to 0.
MTS FILTER check	Remote control unit		No.6 FILTER	<ol style="list-style-type: none"> 1. Select the No.6 FILTER of the SOUND MODE. 2. Verify that the No.6 FILTER is set at its initial setting value.
MTS SEPARATION adjustment	TV audio multiplex signal generator Oscilloscope Remote control unit	1 pin AUDIO_L 2 pin AUDIO_R 3 pin GND [MPX Connector in AV SELECTOR PWB]	No.7 LOW SEP. No.8 HI SEP.	<p>Note: Menu "MTS" is set to "STEREO"</p> <ol style="list-style-type: none"> 1. Input a stereo L signal (300Hz) from the TV audio multiplex signal generator to the antenna terminal. 2. Connect an oscilloscope to pin 1 of [MPX] connector, and display one cycle portion of the 300Hz signal. 3. Change the connection of the oscilloscope to pin 2 of [MPX] connector, and enlarge the voltage axis. 4. Select the No.7 LOW SEP. of the SOUND MODE. 5. Set the initial setting value of the No.7 LOW SEP. with the LEFT/RIGHT key of the remote control unit. 6. Adjust the No.7 LOW SEP. so that the 300Hz signal level will become minimum. 7. Change the signal to 3kHz, and connect an oscilloscope to pin 1 of [MPX] connector. 8. Adjust the No.8 HI SEP. so that the 3kHz signal level will become minimum.

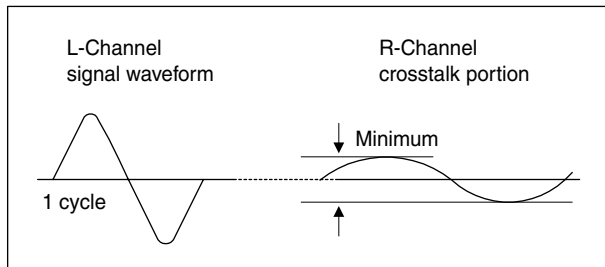

ADJUSTMENTS OF PURITY AND CONVERGENCE

Note: The final adjustment of CONVERGENCE must be done after the FOCUS adjustment. (CONVERGENCE is changed by FOCUS adjustment.)
When makes difference by FOCUS adjustment, should be reconfirming PURITY adjustment.

PURITY ADJUSTMENT

1. Demagnetize CRT with the demagnetizer.
2. Loosen the retainer screw of the deflection yoke.
3. Remove the wedges.
4. Input a green raster signal from the signal generator, and turn the screen to green raster.
5. Move the deflection yoke backward.
6. Bring the long lug of the purity magnets on the short lug and position them horizontally. (Fig. 2)
7. Adjust the gap between two lugs so that the GREEN RASTER will come into the center of the screen. (Fig. 3)
8. Move the deflection yoke forward, and fix the position of the deflection yoke so that the whole screen will become green.
9. Insert the wedge to the top side of the deflection yoke so that it will not move.
10. Input a crosshatch signal.
11. Verify that the screen is horizontal.
12. Input red and blue raster signals, and make sure that purity is properly adjusted.

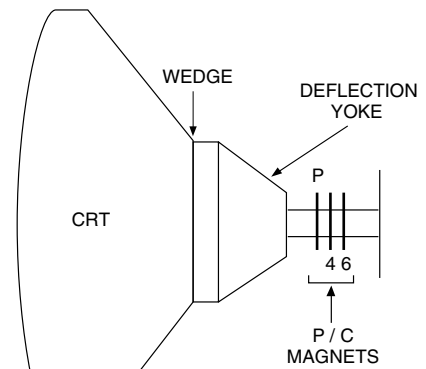

• P/C MAGNETS

P : PURITY MAGNET
4 : 4 POLES (convergence magnets)
6 : 6 POLES (convergence magnets)

Fig. 1

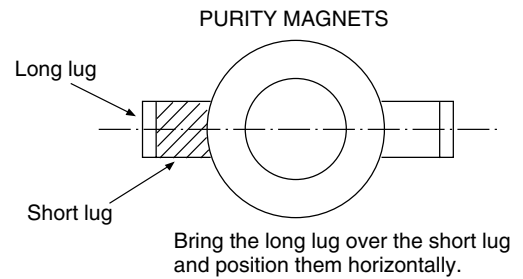

Fig. 2

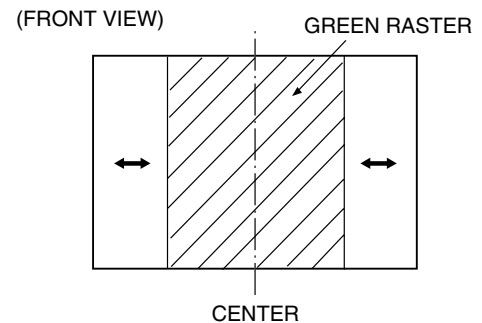

Fig. 3

STATIC CONVERGENCE ADJUSTMENT

1. Input a crosshatch signal.
2. Using 4-pole convergence magnets, overlap the red and blue lines in the center of the screen (Fig. 4) and turn them to magenta (red/blue).
3. Using 6-pole convergence magnets, overlap the magenta (red/blue) and green lines in the center of the screen and turn them to white.
4. Repeat 2 and 3 above, and make best convergence.

DYNAMIC CONVERGENCE ADJUSTMENT

1. Move the deflection yoke up and down and overlap the lines in the periphery. (Fig. 5)
 2. Move the deflection yoke left to right and overlap the lines in the periphery. (Fig. 6)
 3. Repeat 1 and 2 above, and make best convergence.
- After adjustment, fix the wedge at the original position.
Fasten the retainer screw of the deflection yoke.
Fix the P/C magnets with glue.

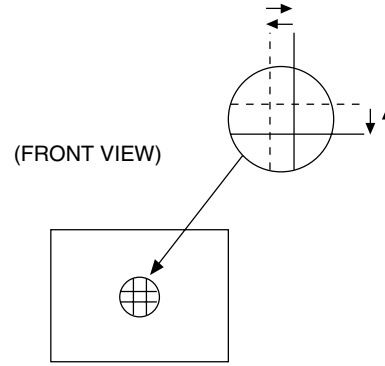

Fig. 4

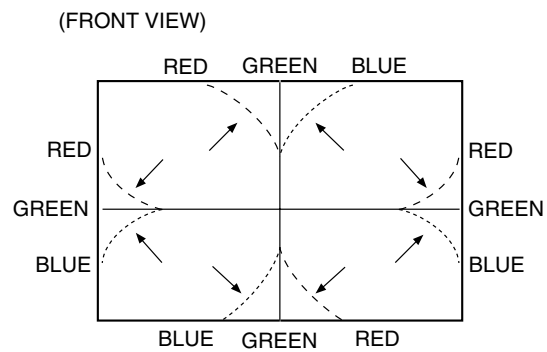

Fig. 5

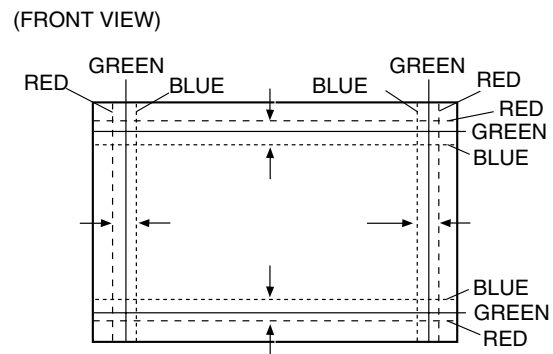

Fig. 6

HOW TO CHECK THE HIGH VOLTAGE HOLD DOWN CIRCUIT

1. HIGH VOLTAGE HOLD DOWN CIRCUIT

After repairing the high voltage hold down circuit shown in Fig. 1.
This circuit shall be checked to operate correctly.

2. CHECKING OF THE HIGH VOLTAGE HOLD DOWN CIRCUIT

- (1) Turn the POWER SW ON.
- (2) As shown in Fig. 1, set the resistor (between S1 connector 1 & 3).
- (3) Make sure that the screen picture disappears.
- (4) Temporarily unplug the power cord.
- (5) Remove the resistor (between S1 connector 1 & 3).
- (6) Again plug the power cord, make sure that the normal picture is displayed on the screen.

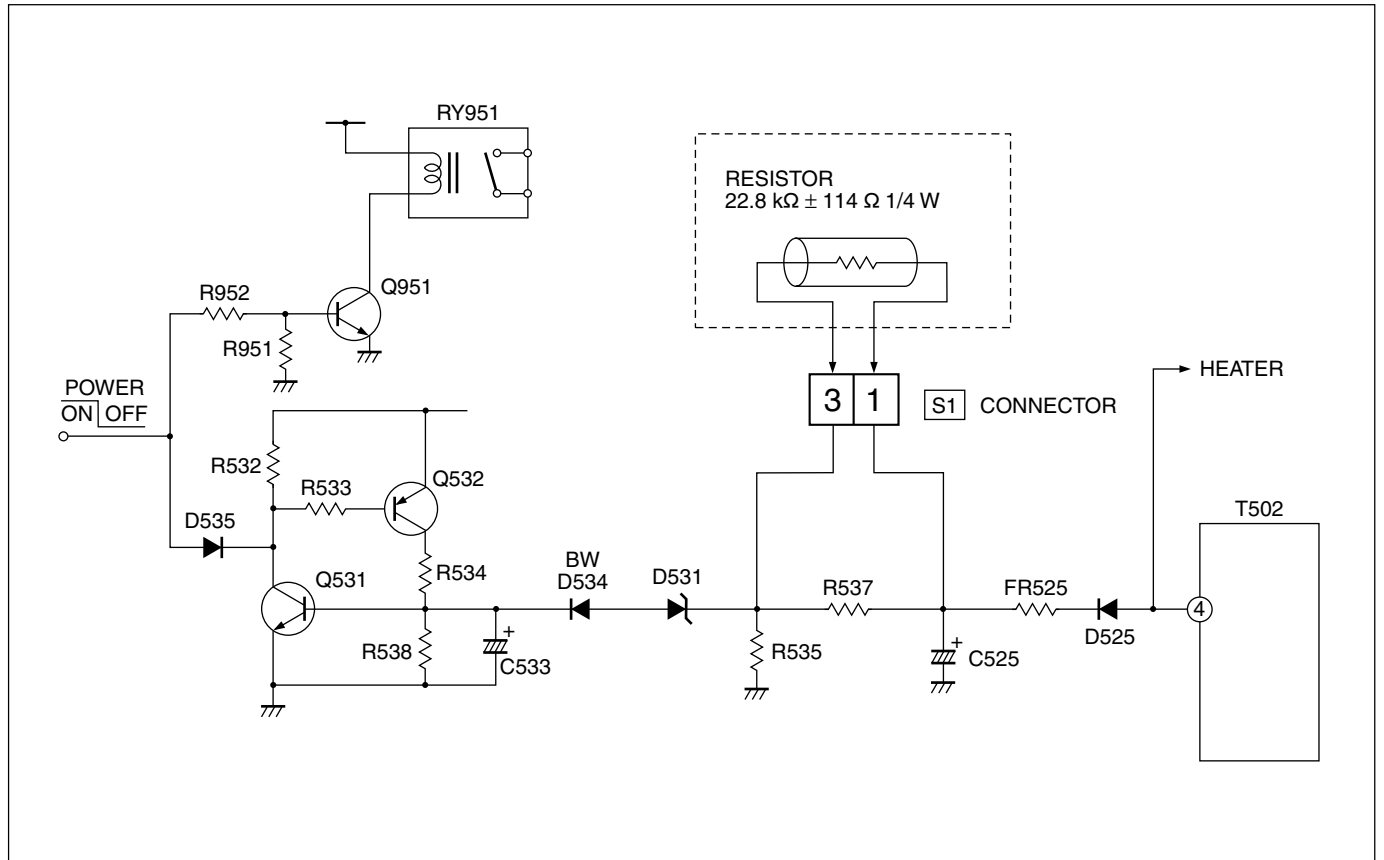

Fig. 1

SELF CHECK FUNCTIONS

1. Outline

This model has self check functions given below. When a malfunction has been detected, the POWER is turned off and the LED flashes to inform of the failure . The malfunction is detected by the signal input state of the control line connected to the microcomputer.

2. Self check items

Check item	Details of detection	Method of detection	State of malfunction
Over-current protector	Operation of B1 protector circuit.	The microcomputer detects at 1 second intervals. If NG is detected for more than 200 ms, a malfunction is interpreted.	When a malfunction has been detected, the POWER is turned off. While the POWER is being turned off , the power key of the remote controller is not operational until the power code is taken out and put in again.

3. Self check indicating function

The self-check function begins detection about 5 seconds after power is supplied.

In the event a malfunction is detected, the power is cut off immediately.

At this time, the ON-TIMER LED flashes to inform of the malfunction.

[ON-TIMER LED indication]

The ON-TIMER LED flashes at 0.5 seconds intervals.

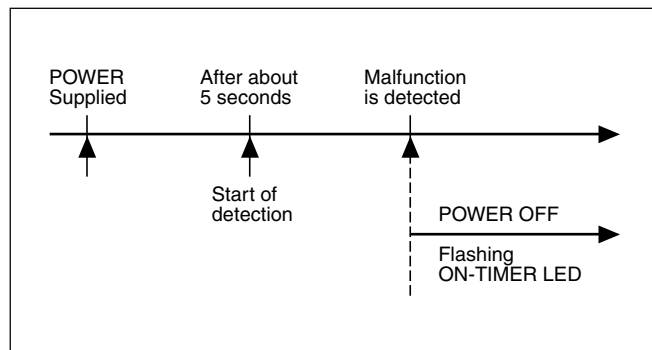

JVC SERVICE & ENGINEERING COMPANY OF AMERICA

DIVISION OF JVC AMERICAS CORP.

Head office :	1700 Valley Road, Wayne, New Jersey 07470	(973)317-5000
East Coast :	10 New Maple Avenue, Pine Brook, New Jersey 07058	(973)396-1000
Midwest :	705 Enterprise St. Aurora, Illinois 60504	(630)851-7855
West Coast :	5665 Corporate Avenue, Cypress, California 90630	(714)229-8011
Southwest :	10700 Hammerly, Suite 105, Houston, Texas 77043	(713)935-9331
Hawaii :	2969 Mapunapuna Place, Honolulu, Hawaii 96819	(808)833-5828
Southeast :	1500 Lakes Parkway, Lawrenceville, Georgia 30243	(770)339-2582

JVC CANADA INC.

Head office :	21 Finchdene Square Scarborough, Ontario M1X 1A7	(416)293-1311
Vancouver :	13040 Worster Court Richmond B.C. V6V 2B3	(604)270-1311

JVC®

AV32230AG-UCM #4	AV32260AG-UCM #4
AV32230AH-UCM #4	AV32260AH-UCM #4
AV32230AM-UCM #4	AV32260AM-UCM #4
AV32230AR-UCM #4	AV32260AR-UCM #4



Printed in Japan
VP0112
SW